

Product Sheet



Item No.

080 S W S 4 R 0 N

housing / data

housing type
series
fixing type
hole dimensions / hub width
thickness of fixing / fork
surface treatment



wheel / data

diameter	80 mm
wheel center	Steel Rim white
wheel tread	solid rubber white
bearing	roller bearing
threadguard	no separate threadguard
hub width	40 mm
axle diameter	M 8
temperature range	-20°C - +60°C
dyn. load capacity	70 kg
test norm	DIN EN 12532

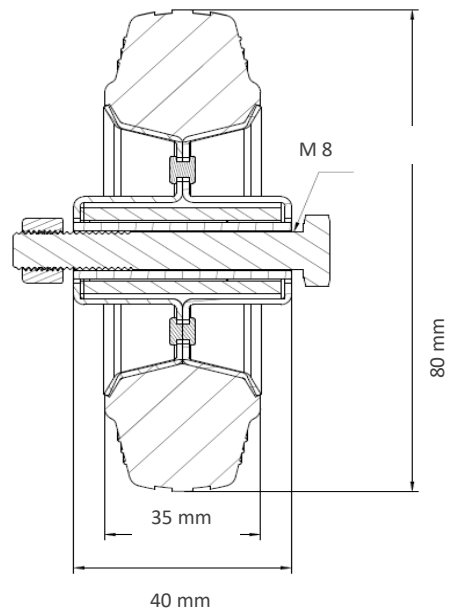
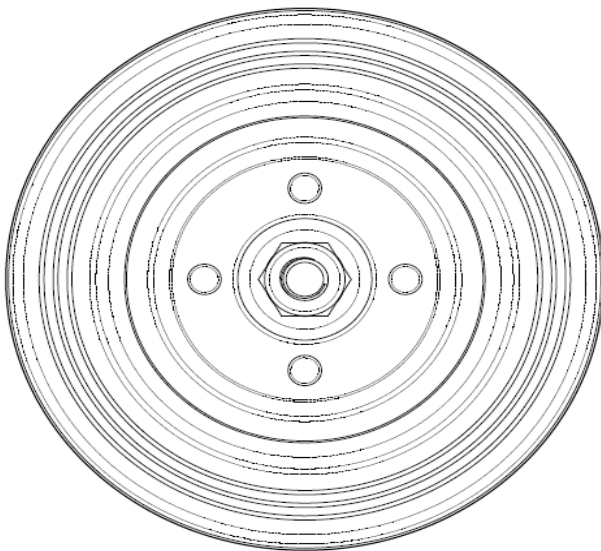
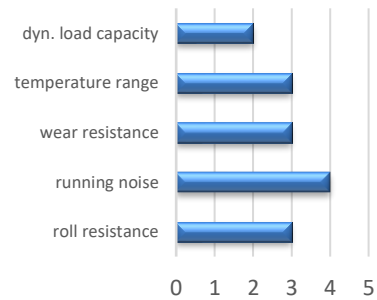

Deviation possible! All information is subject to change.