

Product Sheet



Item No.

080 N 0 N 0 R 1 W

housing / data

housing type
series
fixing type
hole dimensions / hub width
thickness of fixing / fork
surface treatment



wheel / data

diameter	80 mm
wheel center	Polyamide white
wheel tread	Polyamide white
bearing	roller bearing
threadguard	small metal threadguard
hub width	40 mm
axle diameter	M 8
temperature range	-40°C - +80°C
dyn. load capacity	130 kg
test norm	DIN EN 12532

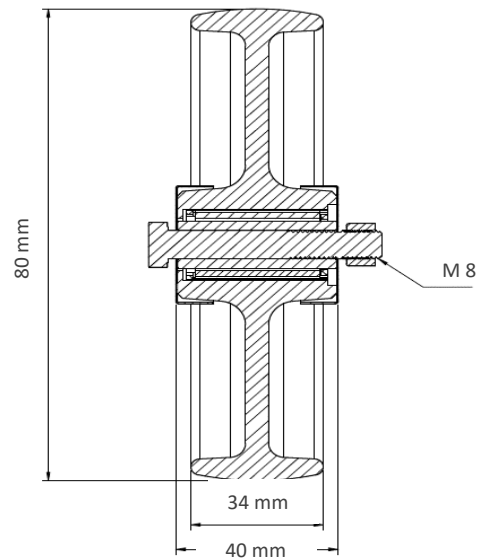
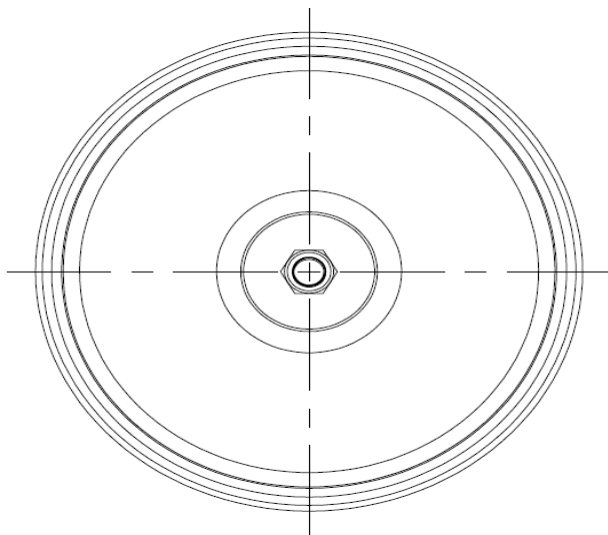
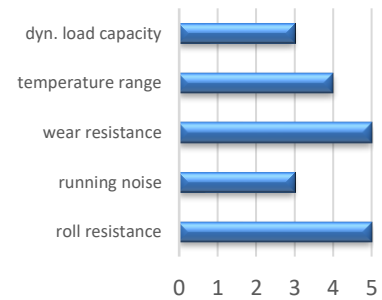

Deviation possible! All information is subject to change.