

Product Sheet



Item No.

250 B A U 5 D 0 N

housing / data

housing type
series
fixing type
hole dimensions / hub width
thickness of fixing / fork
surface treatment

wheel / data

diameter	250 mm
wheel center	Aluminium (Heavy Duty)
wheel tread	Polyurethane brown
bearing	double ball bearing
threadguard	no separate threadguard
hub width	60 mm
axle diameter	M 12
temperature range	-20°C - +60°C
dyn. load capacity	800 kg
test norm	DIN EN 12532

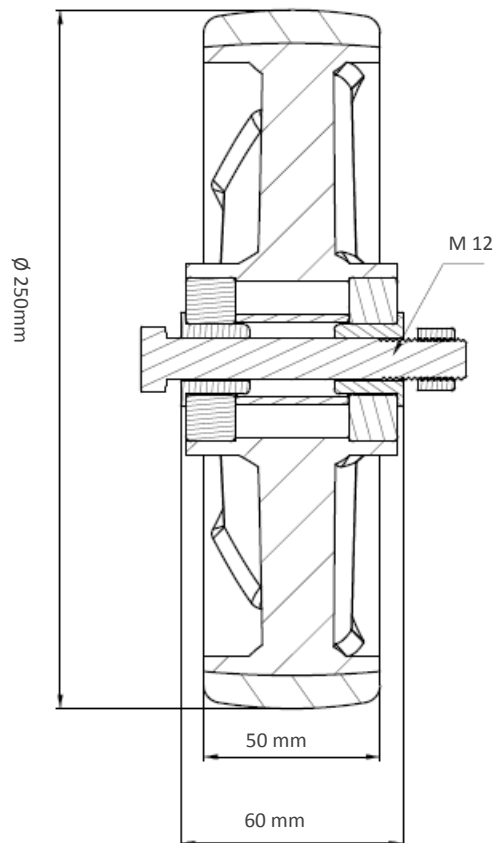
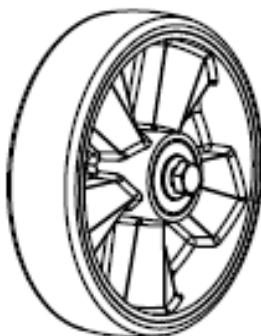
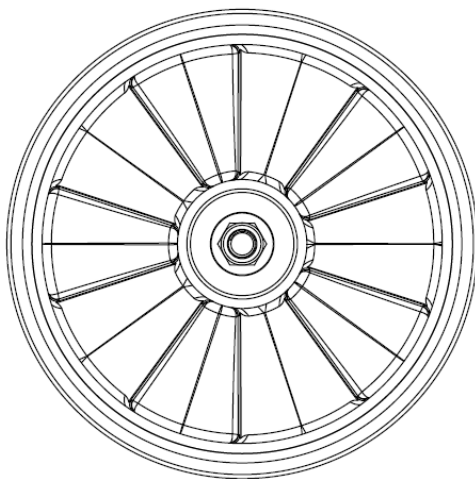

Deviation possible! All information is subject to change.