

Product Sheet



Item No. B A H 1 5 C C 150 P 2 T 2 B 4 2

housing / data

housing type	bolt hole castor with total brake
series	apparatus
fixing type	bolt hole
hole dimensions / hub width	11 mm Diameter / 22-36 mm
thickness of fixing / fork	2.50 mm / 2.50 mm
surface treatment	zinc-chromatised

wheel / data

diameter	150 mm
wheel center	Polypropylene grey
wheel tread	thermopl. rubber 95° Shore A grey
bearing	single ball bearing
threadguard	full covering plastic threadguard
hub width	36 mm
axle diameter	M 8
temperature range	-20°C - +60°C
dyn. load capacity	100 kg
test norm	DIN EN 12530

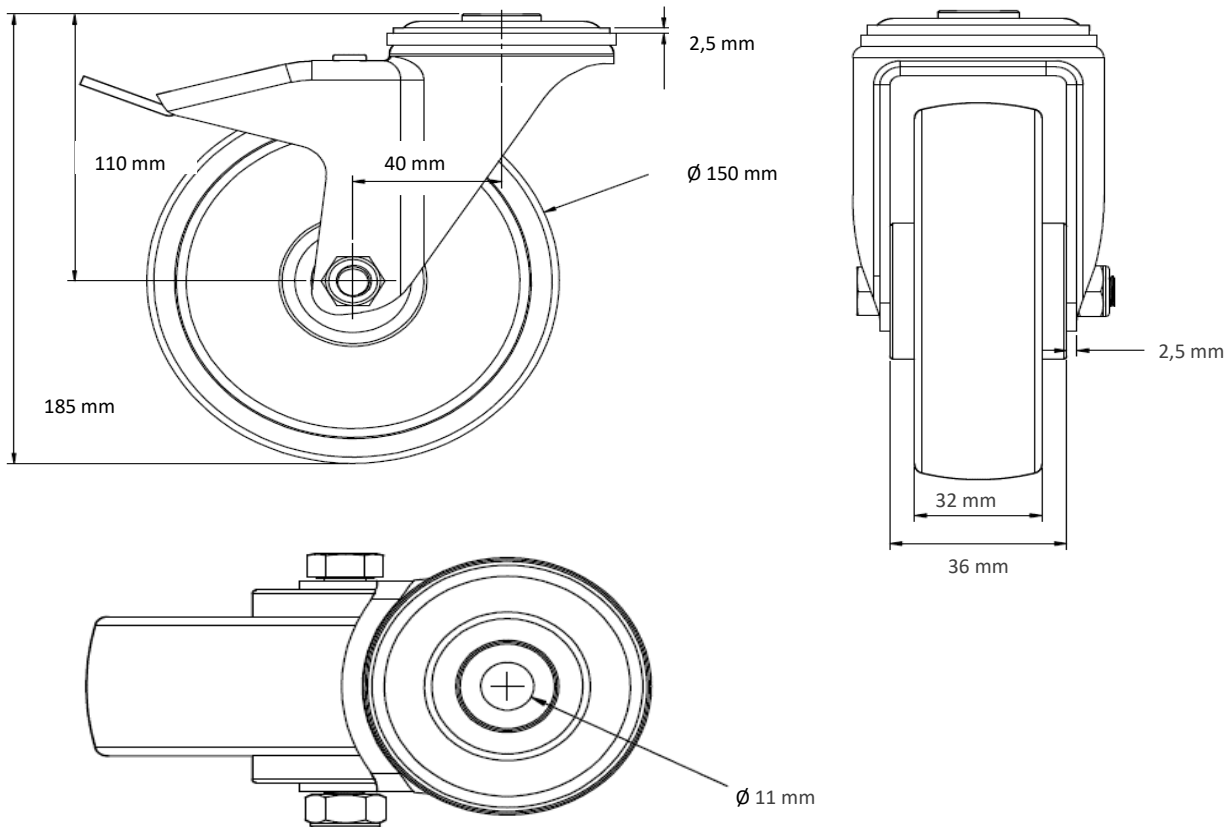

Deviation possible! All information is subject to change.