

Product Sheet



Item No. B B H 3 5 W C 080 R 4 F 1 R 0 N

housing / data

housing type bolt hole castor with total brake
 series CASCOO Basics
 fixing type bolt hole
 hole dimensions / hub width 13 mm Diameter / 42 mm
 thickness of fixing / fork 2.50 mm / 2.50 mm
 surface treatment galvanized blue zinc



wheel / data

diameter 80 mm
 wheel center Polyamide black
 wheel tread elastic 70-75° Shore A blue
 bearing roller bearing
 threadguard no separate threadguard
 hub width 40 mm
 axle diameter M 8
 temperature range -20°C - +80°C
 dyn. load capacity 130 kg
 test norm DIN EN 12532

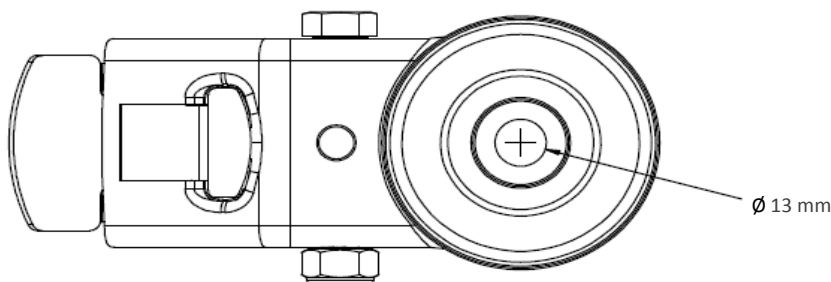
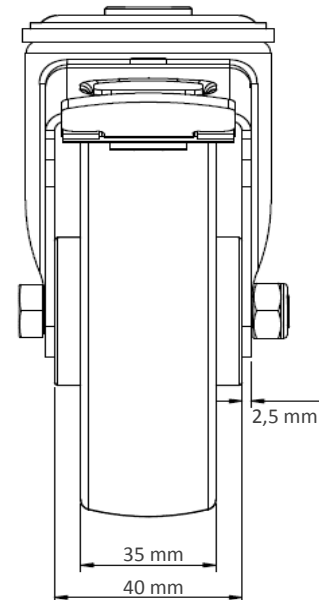
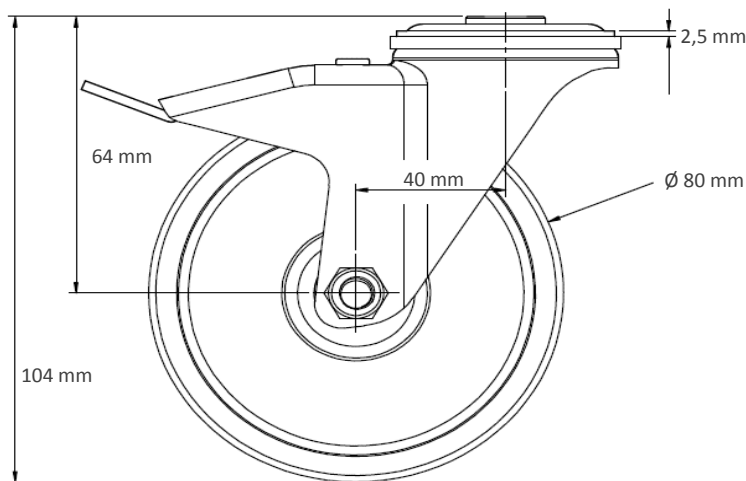
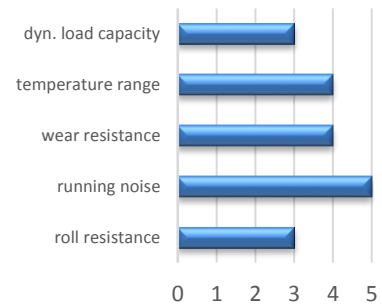

Deviation possible! All information is subject to change.