

Product Sheet



Item No. B P H 9 8 W C 200 N 0 N 0 R 1 W

housing / data

housing type	bolt hole castor with total brake
series	CASCOO Premium
fixing type	bolt hole
hole dimensions / hub width	13 mm Diameter / 60 mm
thickness of fixing / fork	3.50 mm / 3.00 mm
surface treatment	galvanized blue zinc



wheel / data

diameter	200 mm
wheel center	Polyamide white
wheel tread	Polyamide white
bearing	roller bearing
threadguard	small metal threadguard
hub width	60 mm
axle diameter	M 12
temperature range	-40°C - +80°C
dyn. load capacity	200 kg
test norm	DIN: EN 12532

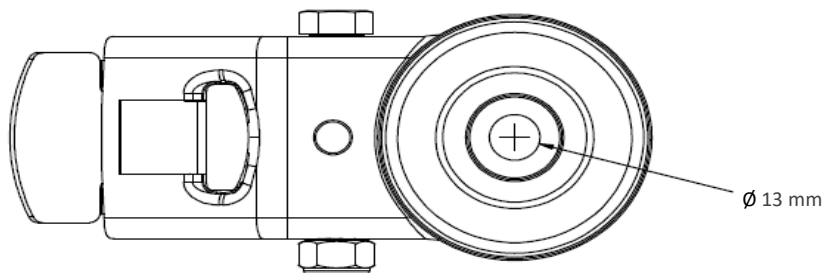
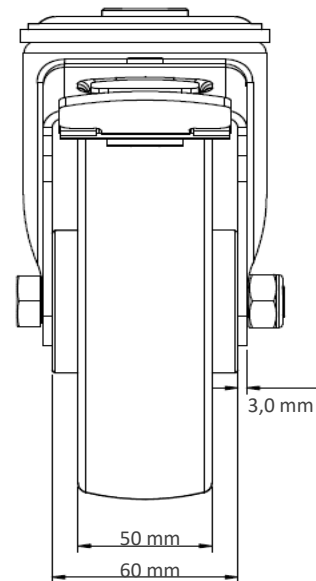
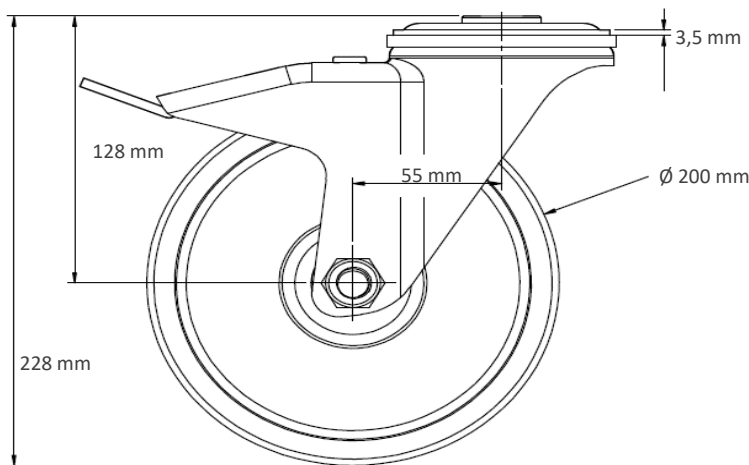
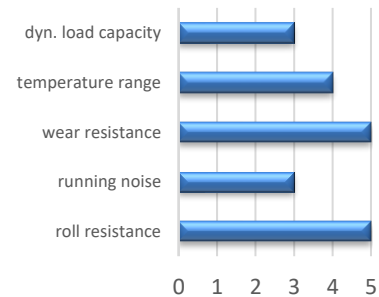

Deviation possible! All information is subject to change.