

Product Sheet



Item No. F B P 2 2 W C 080 P 4 R 2 R 0 N

housing / data

housing type fixed castor
 series CASCOO Basics
 fixing type fixing plate
 hole dimensions / hub width 80 x 60 mm / 52 mm
 thickness of fixing / fork 2.00 mm / 2.00 mm
 surface treatment galvanized blue zinc



wheel / data

diameter 80 mm
 wheel center Polypropylene black
 wheel tread solid rubber grey
 bearing roller bearing
 threadguard no separate threadguard
 hub width 40 mm
 axle diameter M 8
 temperature range -20°C - +60°C
 dyn. load capacity 70 kg
 test norm DIN EN 12532

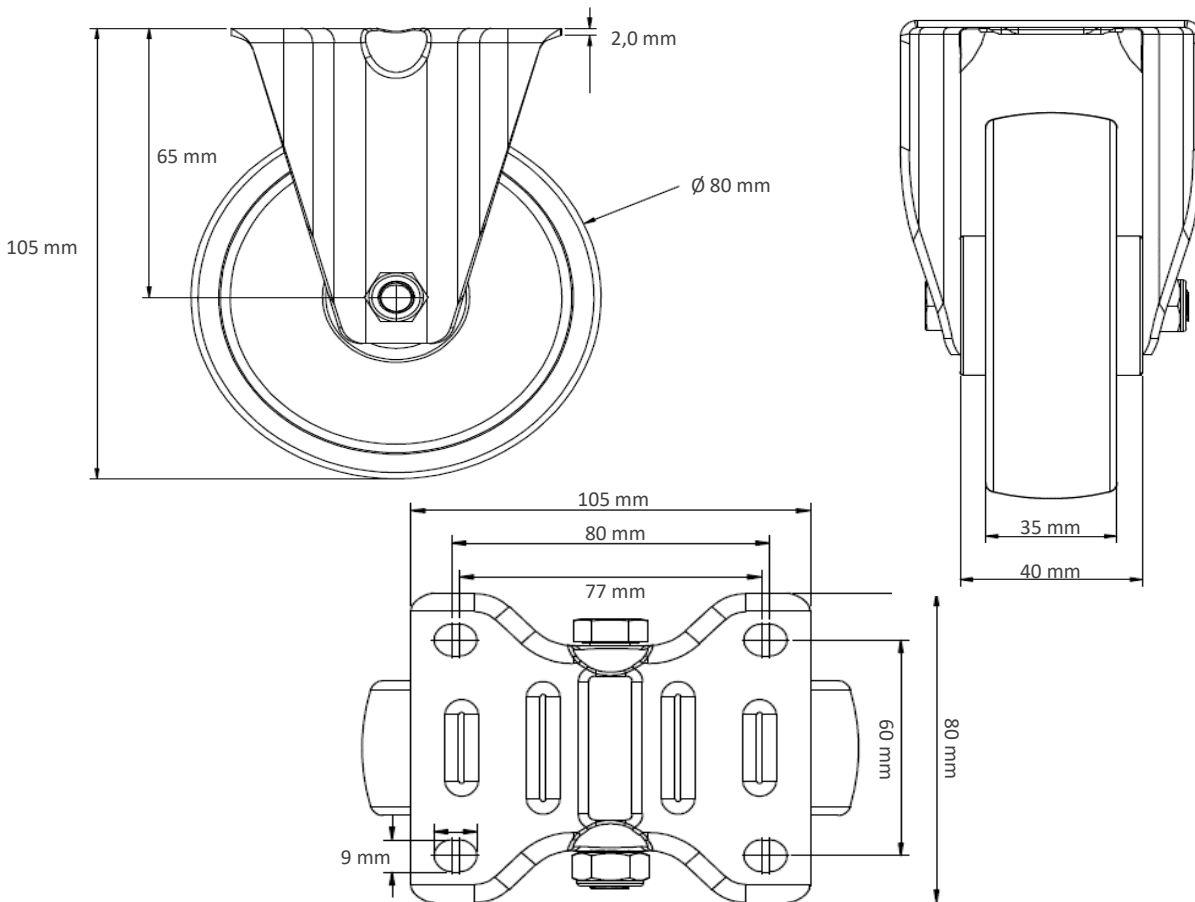
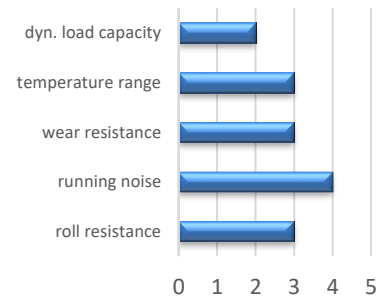

Deviation possible! All information is subject to change.