

Product Sheet



Item No. F B P 2 2 W C 080 S W R 2 R 0 N

housing / data

housing type	fixed castor
series	CASCOO Basics
fixing type	fixing plate
hole dimensions / hub width	80 x 60 mm / 42 mm
thickness of fixing / fork	2.00 mm / 2.00 mm
surface treatment	galvanized blue zinc



wheel / data

diameter	80 mm
wheel center	Steel Rim
wheel tread	solid rubber grey
bearing	roller bearing
threadguard	no separate threadguard
hub width	40 mm
axle diameter	M 8
temperature range	-20°C - +60°C
dyn. load capacity	70 kg
test norm	DIN EN 12532

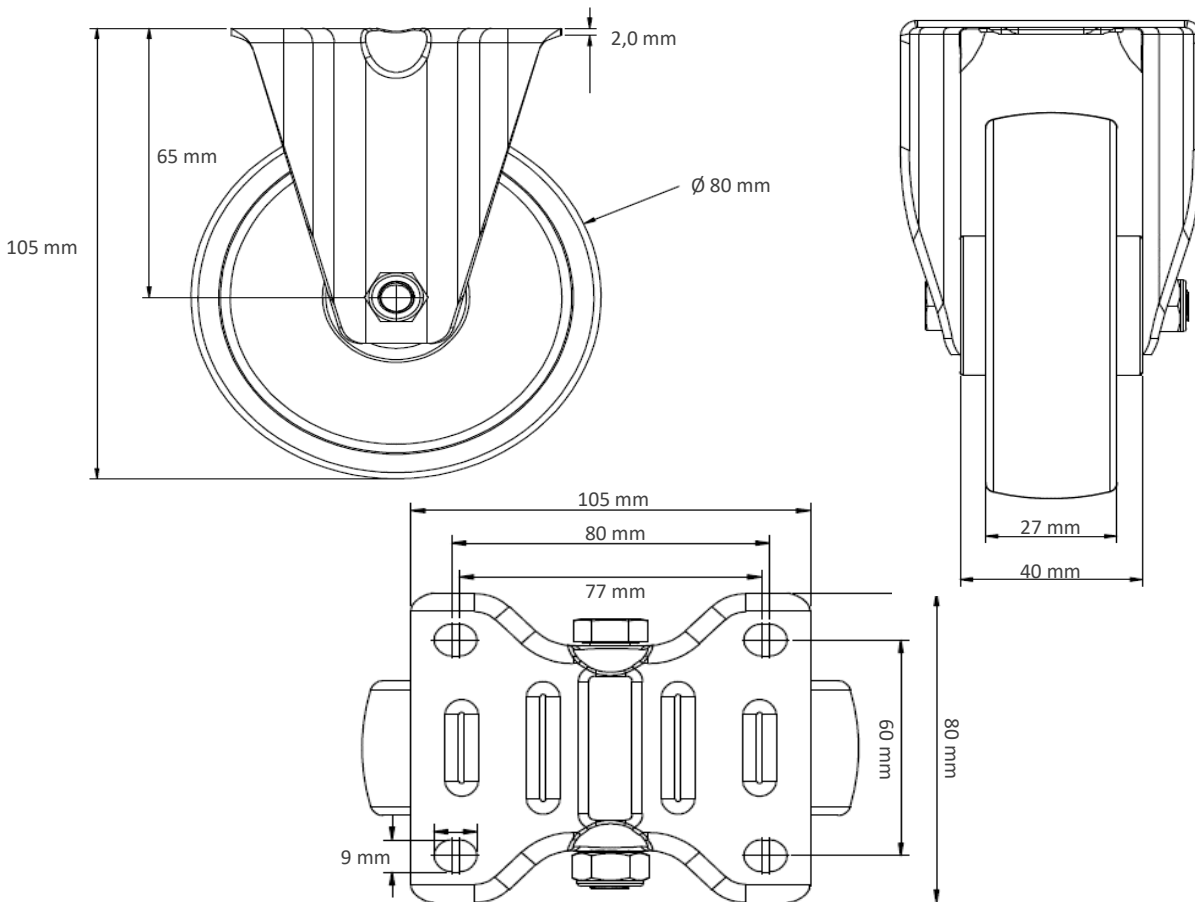
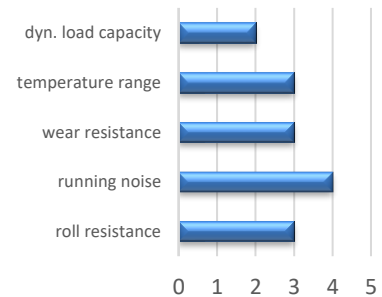

Deviation possible! All information is subject to change.