

Product Sheet



Item No. F P P 2 2 W C 100 N 0 N 0 R 1 W

housing / data

housing type	fixed castor
series	CASCOO Premium
fixing type	fixing plate
hole dimensions / hub width	80 x 60 mm / 42 mm
thickness of fixing / fork	2.00 mm / 2.00 mm
surface treatment	galvanized blue zinc



wheel / data

diameter	100 mm
wheel center	Polyamide white
wheel tread	Polyamide white
bearing	roller bearing
threadguard	small metal threadguard
hub width	40 mm
axle diameter	M 8
temperature range	-40°C - + 80°C
dyn. load capacity	150 kg
test norm	DIN:EN 12532

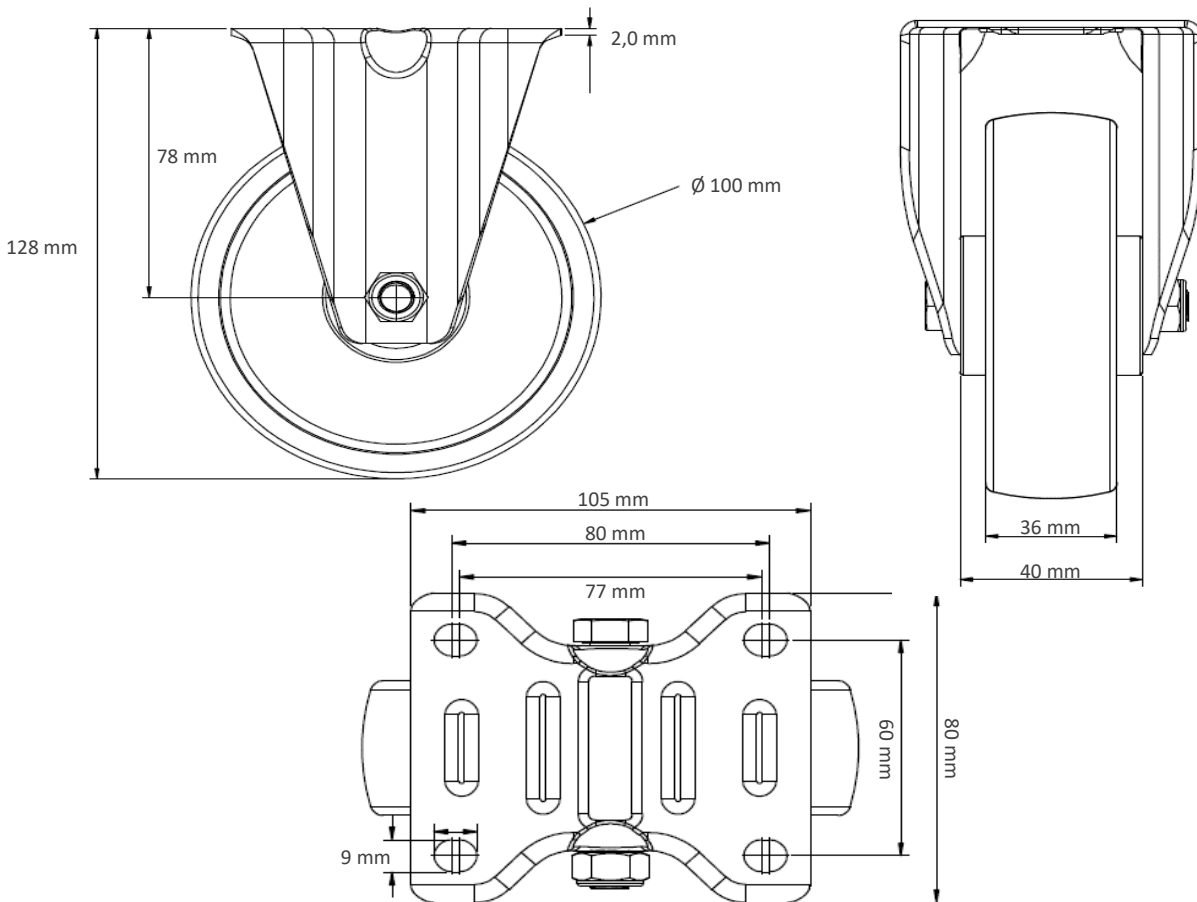
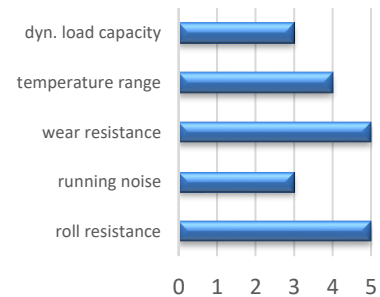

Deviation possible! All information is subject to change.