

Product Sheet



Item No. F P P 5 3 W C 200 R 4 E 2 D 3 4

housing / data

housing type fixed castor
 series CASCOO Premium
 fixing type fixing plate
 hole dimensions / hub width 105 x 80 mm / 60 mm
 thickness of fixing / fork 3.00 mm / 3.00 mm
 surface treatment galvanized blue zinc



wheel / data

diameter 200 mm
 wheel center Polyamide black
 wheel tread elastic 65° Shore A grey
 bearing double ball bearing
 threadguard small plastic threadguard
 hub width 60 mm
 axle diameter M 12
 temperature range -20°C - +80°C
 dyn. load capacity 300 kg
 test norm DIN EN 12532

Attention!! Picture with threadguard

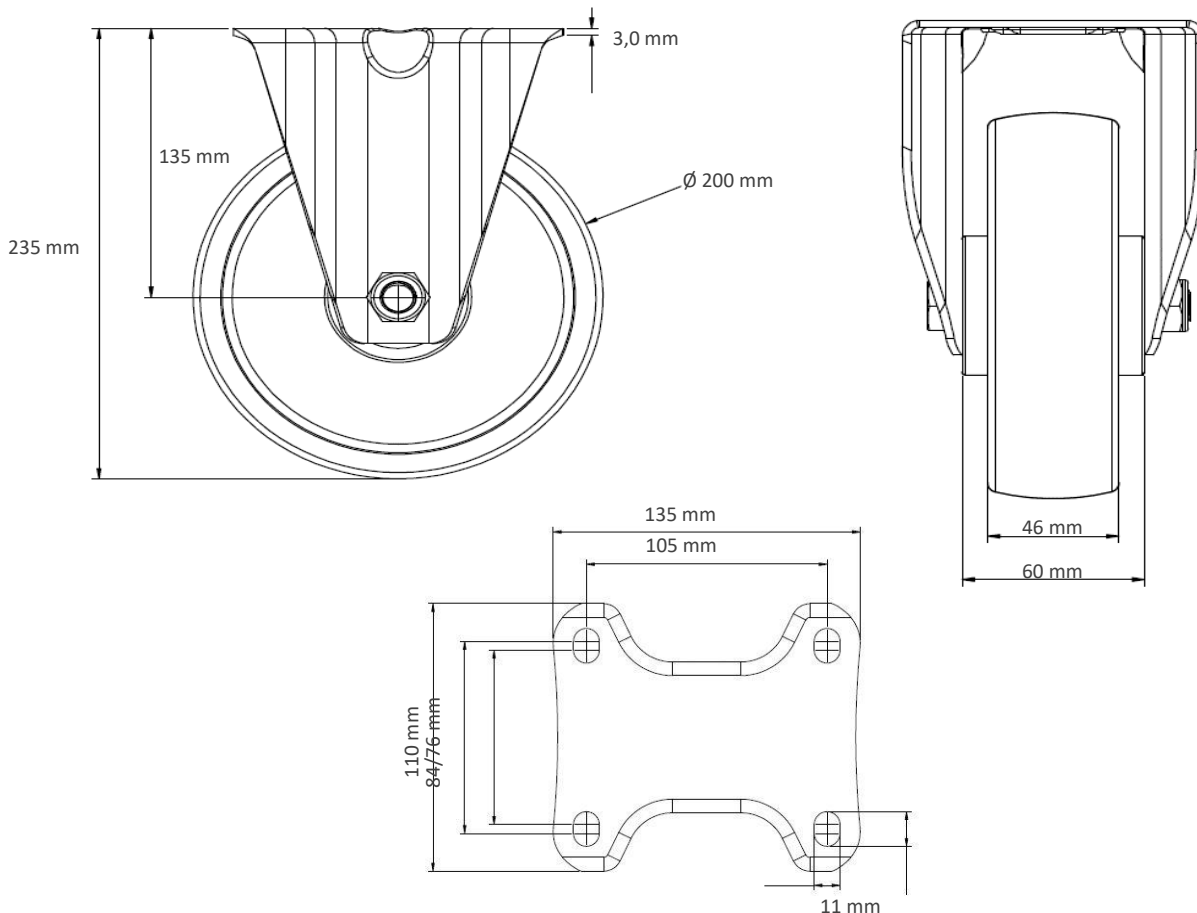
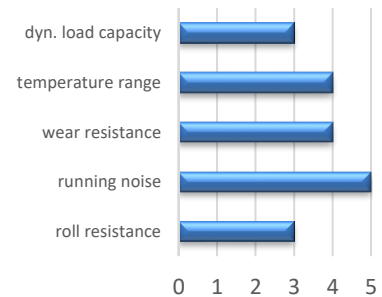

Deviation possible! All information is subject to change.