

Product Sheet



Item No. H P H 9 8 W C 200 S W R 2 R 0 N

housing / data

housing type	swivel castor with hole fitting
series	CASCOO Premium
fixing type	bolt hole
hole dimensions / hub width	13 mm Diameter / 60 mm
thickness of fixing / fork	3.50 mm / 3.00 mm
surface treatment	galvanized blue zinc



wheel / data

diameter	200 mm
wheel center	Steel Rim
wheel tread	solid rubber grey
bearing	roller bearing
threadguard	no separate threadguard
hub width	59 mm
axle diameter	M 12
temperature range	-20°C - +60°C
dyn. load capacity	205 kg
test norm	DIN EN 12532

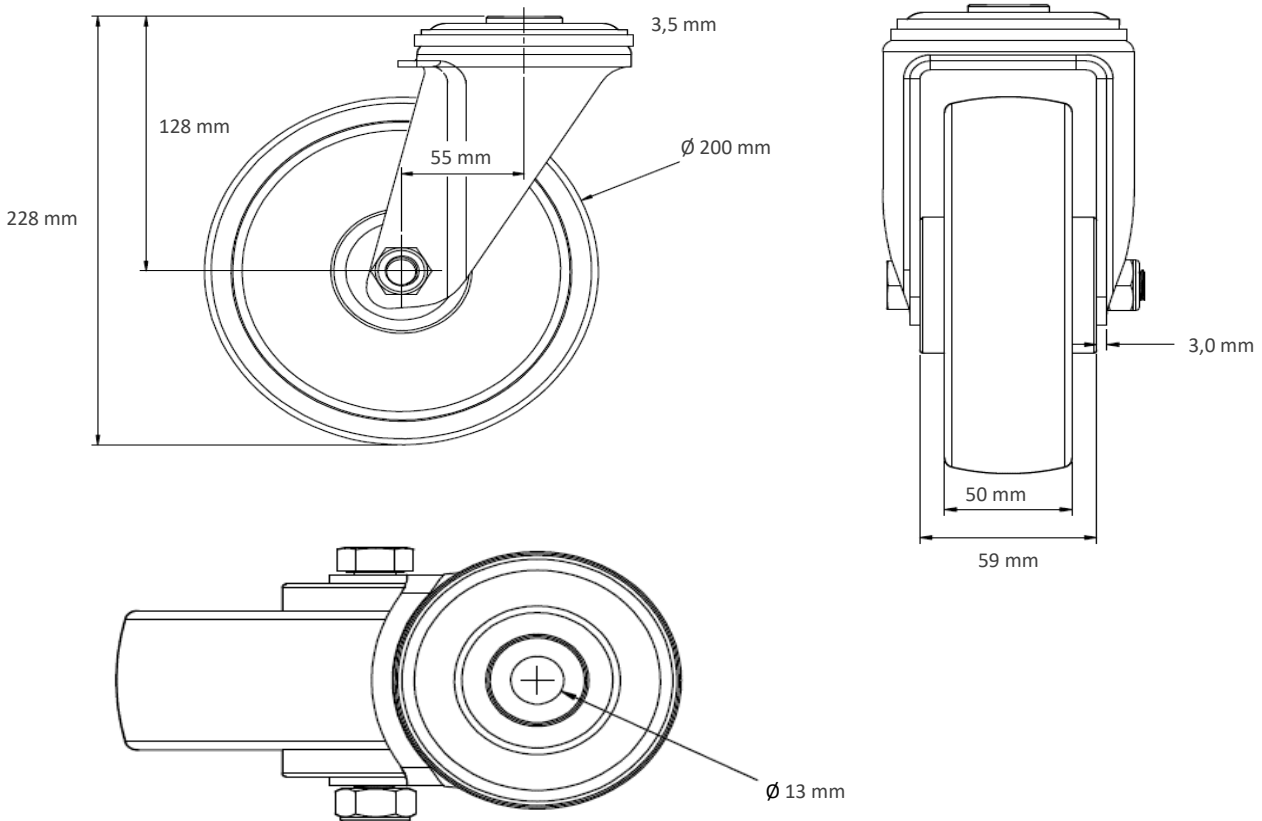
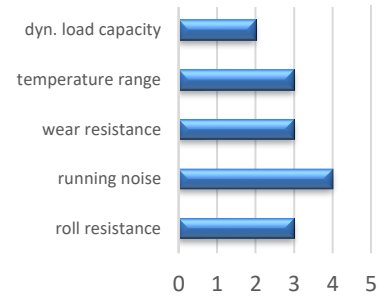

Deviation possible! All information is subject to change.