

Product Sheet



Item No. L G T K B W C 125 N 0 N 0 P 0 N

housing / data

housing type	solid stem and sprung turned part
series	φ38.35*55.5
fixing type	Scaffold
hole dimensions / hub width	solid stem and sprung turned part
thickness of fixing / fork	φ38.35*55.5 stem / 52mm
surface treatment	4.00 mm / 3.50 mm
	galvanized blue zinc



wheel / data

diameter	125 mm
wheel center	Polyamide white
wheel tread	Polyamide white
bearing	plain bearing
threadguard	no separate threadguard
hub width	52 mm
axle diameter	M 12
temperature range	-20°C - +80°C
dyn. load capacity	600 kg
test norm	DIN: EN 1004

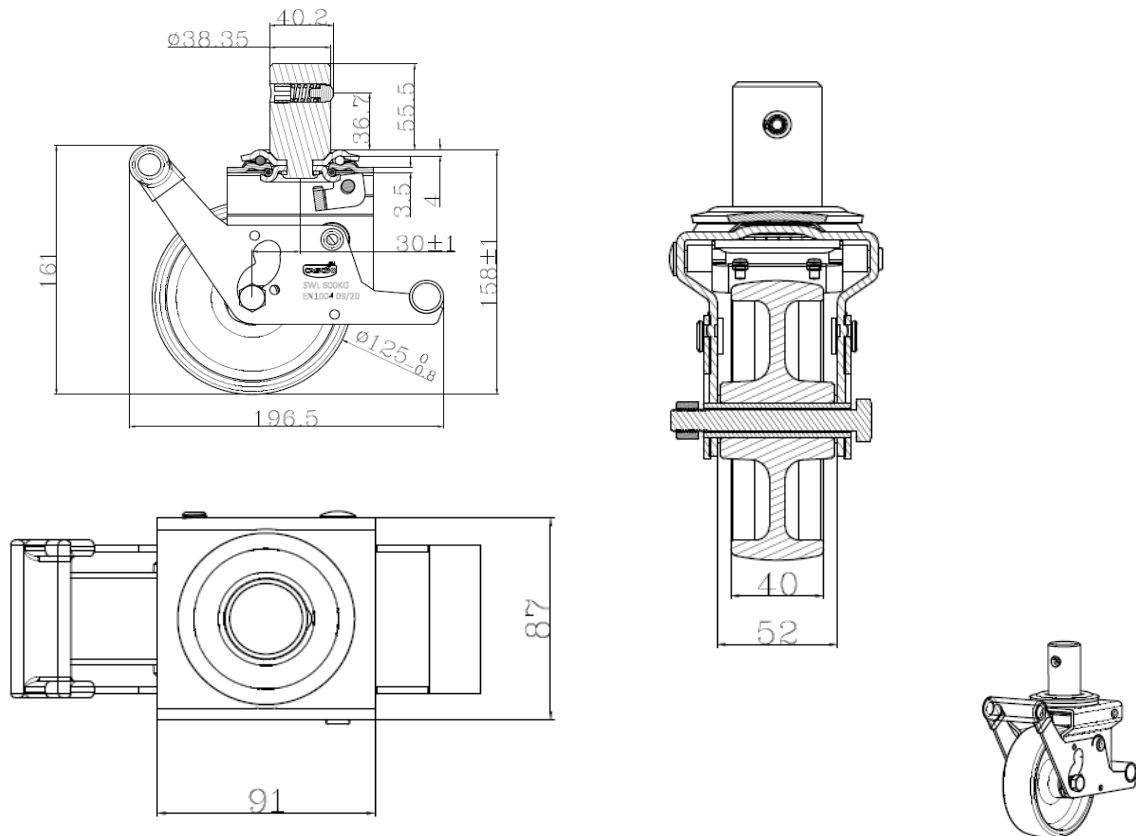

Deviation possible! All information is subject to change.