

Product Sheet



Item No. S B P 2 5 W C 080 R 4 F 1 R 0 N

housing / data

housing type	swivel castor
series	CASCOO Basics
fixing type	fixing plate
hole dimensions / hub width	80 x 60 mm / 42 mm
thickness of fixing / fork	2.50 mm / 2.50 mm
surface treatment	galvanized blue zinc



wheel / data

diameter	80 mm
wheel center	Polyamide black
wheel tread	elastic 70-75° Shore A blue
bearing	roller bearing
threadguard	no separate threadguard
hub width	40 mm
axle diameter	M 8
temperature range	-20°C - +80°C
dyn. load capacity	130 kg
test norm	DIN EN 12532

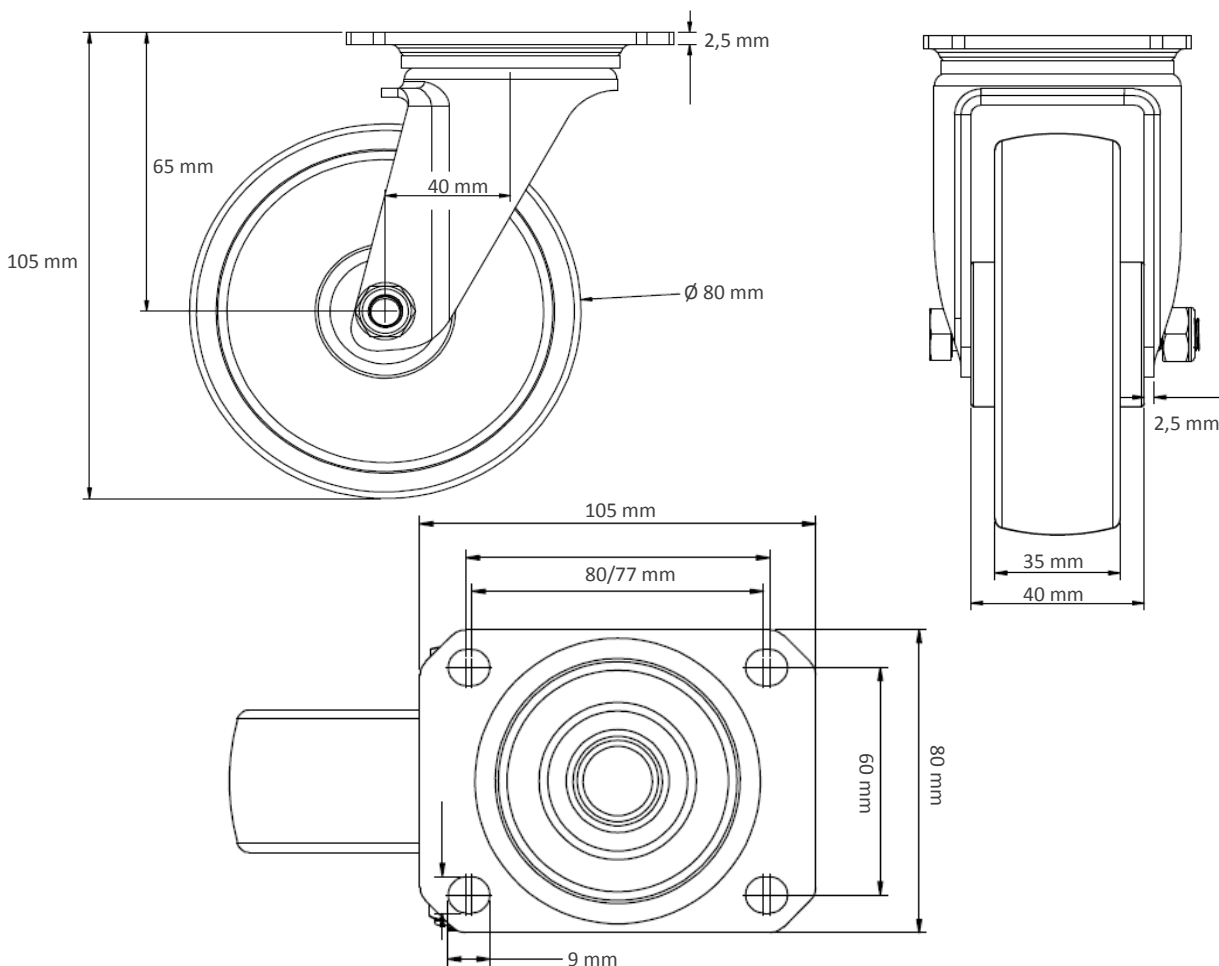
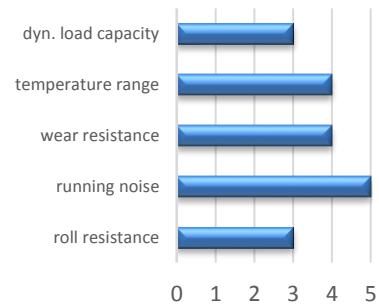

Deviation possible! All information is subject to change.