

Product Sheet



Item No. S B P 3 5 W C 125 P 4 R 2 R 0 N

housing / data

housing type	swivel castor
series	CASCOO Basics
fixing type	fixing plate
hole dimensions / hub width	80 x 60 mm / 52 mm
thickness of fixing / fork	2.50 mm / 2.50 mm
surface treatment	galvanized blue zinc



wheel / data

diameter	125 mm
wheel center	Polypropylene black
wheel tread	solid rubber grey
bearing	roller bearing
threadguard	no separate threadguard
hub width	50 mm
axle diameter	M 10
temperature range	-20°C - +60°C
dyn. load capacity	100 kg
test norm	DIN EN 12532

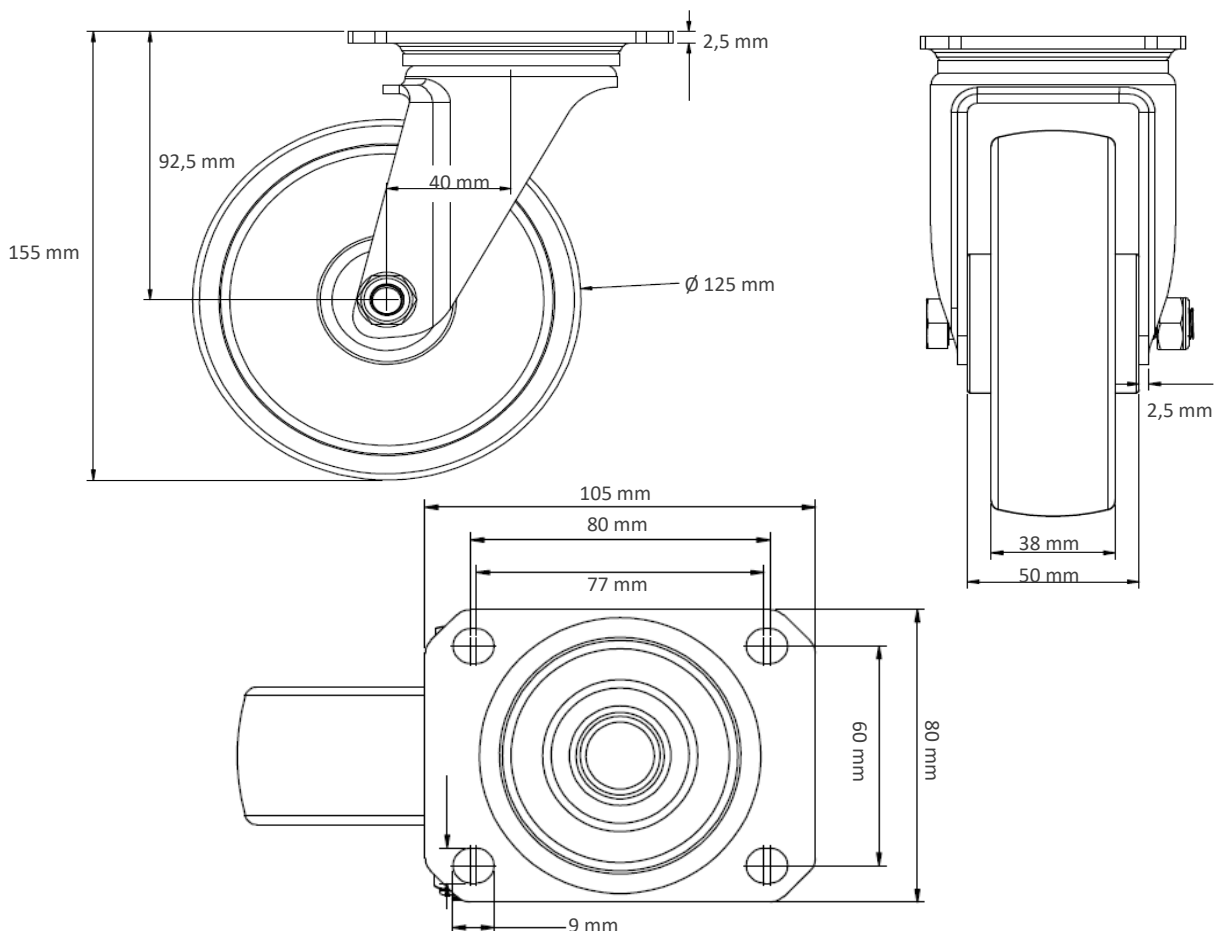
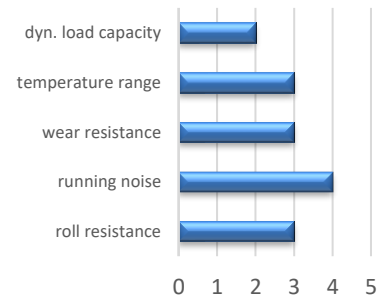

Deviation possible! All information is subject to change.