

Product Sheet



Item No. S C P J S P C 125 P 2 A 2 B 4 2

housing / data

housing type	swivel castor
series	CASCOO Cara
fixing type	fixing plate
hole dimensions / hub width	77 X 67 mm / 36 mm
thickness of fixing / fork	3.0 mm
surface treatment	PA grey with fiberglass particles

wheel / data

diameter	125 mm
wheel center	Polypropylene grey
wheel tread	Thermopl. Rubber grey 85° Shore A
bearing	single ball bearing
threadguard	full covering plastic threadguard
hub width	36 mm
axle diameter	M 8
temperature range	-20°C - +60°C
dyn. load capacity	110 kg

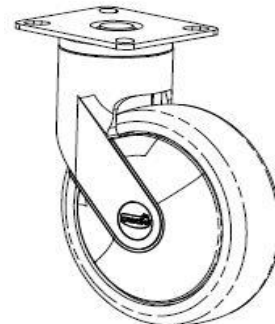
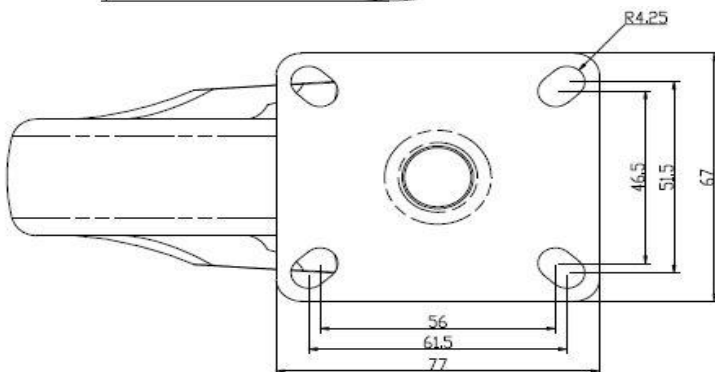
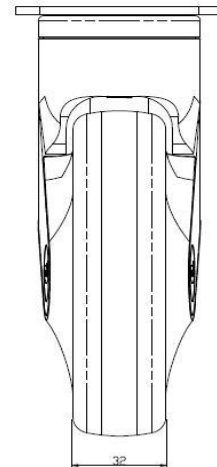
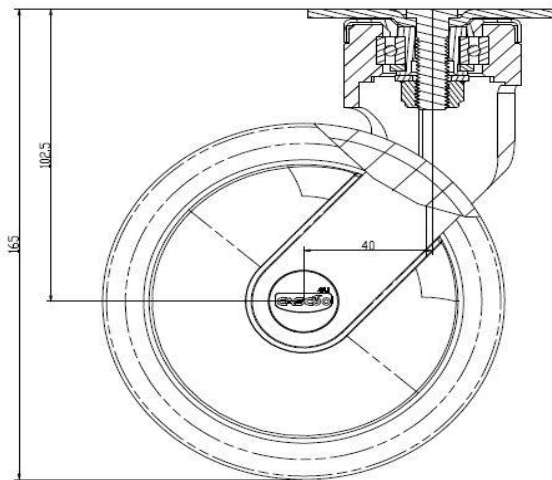

Deviation possible! All information is subject to change.