

Product Sheet



Item No. S H P 5 E W C 200 Z 4 U 5 D 3 4

housing / data

housing type	swivel castor
series	heavy duty
fixing type	fixing plate
hole dimensions / hub width	105 x 80 mm / 60 mm
thickness of fixing / fork	5.00 mm / 4.00 mm
surface treatment	galvanized blue zinc



wheel / data

diameter	200 mm
wheel center	Polyamide black
wheel tread	Polyurethane brown
bearing	double ball bearing
threadguard	small plastic threadguard
hub width	60 mm
axle diameter	M 12
temperature range	-20°C - +60°C
dyn. load capacity	500 kg
test norm	DIN EN 12533

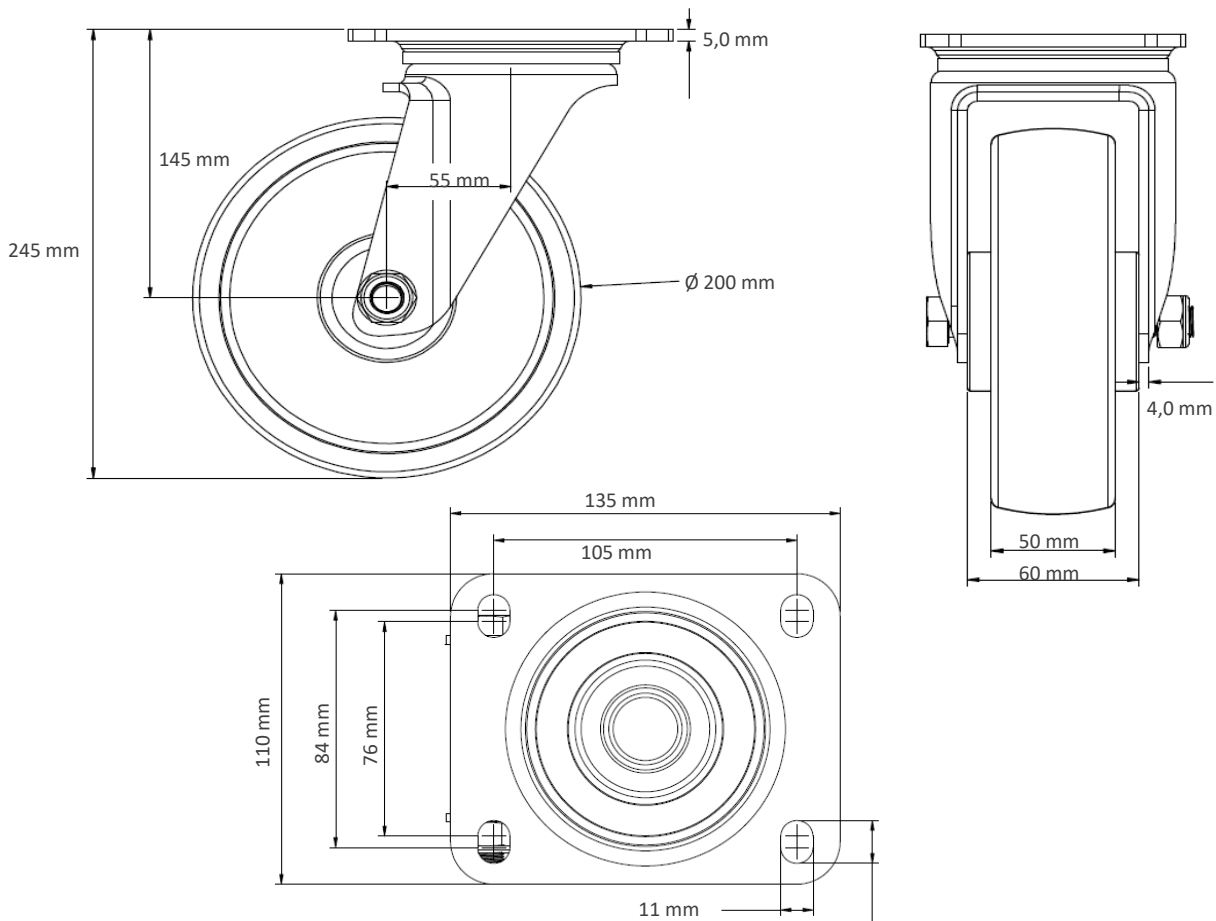

Deviation possible! All information is subject to change.