

Product Sheet



Item No. S P P 2 1 W C 080 N 2 U 6 B 3 2

housing / data

housing type	swivel castor
series	CASCOO Premium
fixing type	fixing plate
hole dimensions / hub width	80 x 60 mm / 42 mm
thickness of fixing / fork	3.00 mm / 2.50 mm
surface treatment	galvanized blue zinc



wheel / data

diameter	80 mm
wheel center	Polyamide white
wheel tread	Polyurethane white
bearing	single ball bearing
threadguard	small plastic threadguard
hub width	40 mm
axle diameter	M 8
temperature range	-40°C - +80°C
dyn. load capacity	130 kg
test norm	DIN: EN 12532

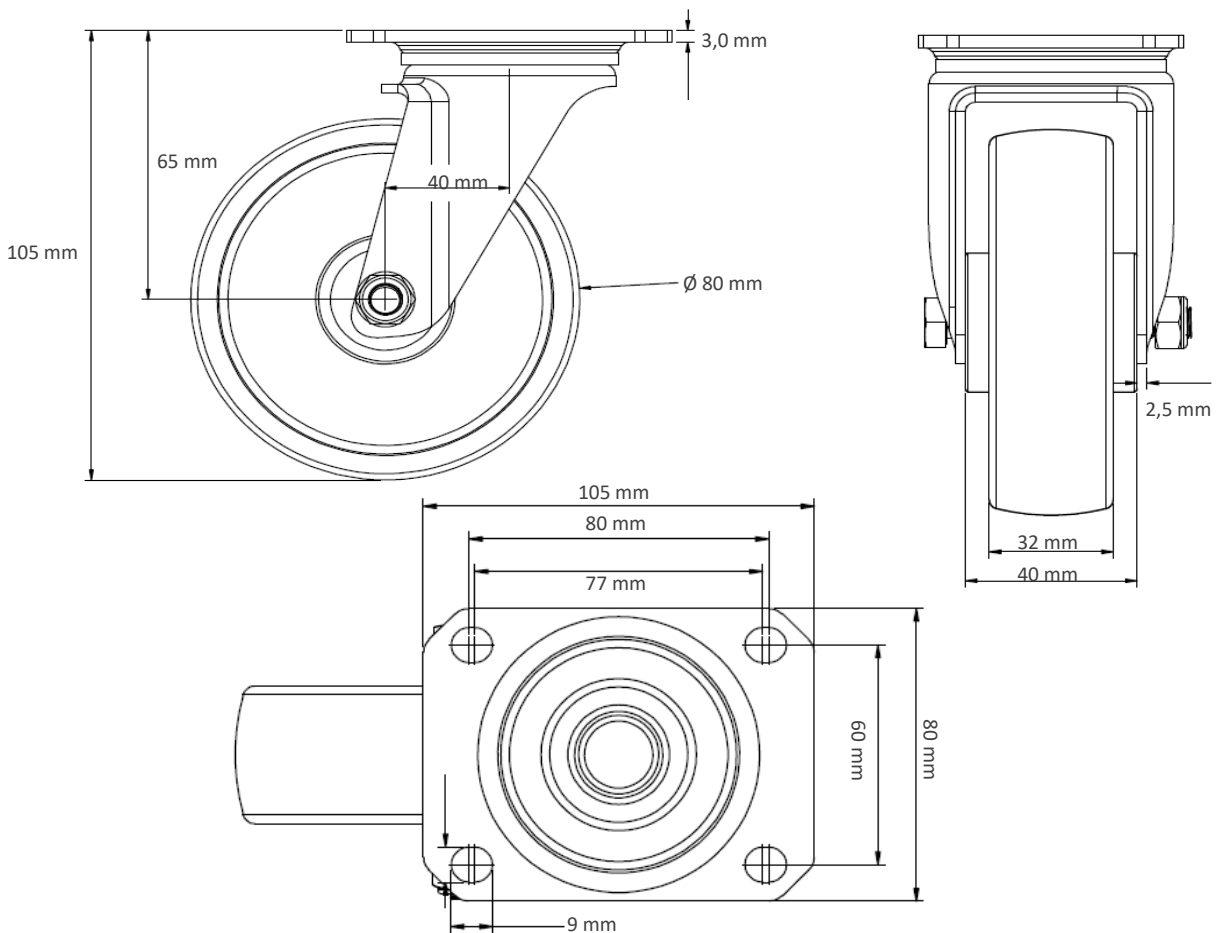
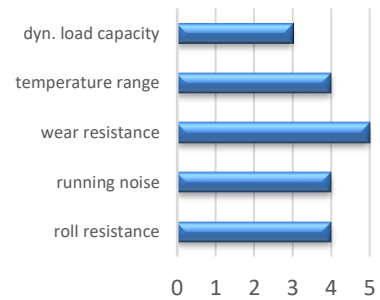

Deviation possible! All information is subject to change.