

Product Sheet



Item No. S P P 2 1 W C 100 N 4 B 5 B 3 4

housing / data

housing type	swivel castor
series	CASCOO Premium
fixing type	fixing plate
hole dimensions / hub width	80 x 60 mm / 42 mm
thickness of fixing / fork	3.00 mm / 2.50 mm
surface treatment	galvanized blue zinc



wheel / data

diameter	100 mm
wheel center	Polyamide black
wheel tread	polyurethane 92° Shore A brown
bearing	single ball bearing
threadguard	small plastic threadguard
hub width	40 mm
axle diameter	M8
temperature range	-20°C - +80°C
dyn. load capacity	200 kg
test norm	DIN: EN 12532

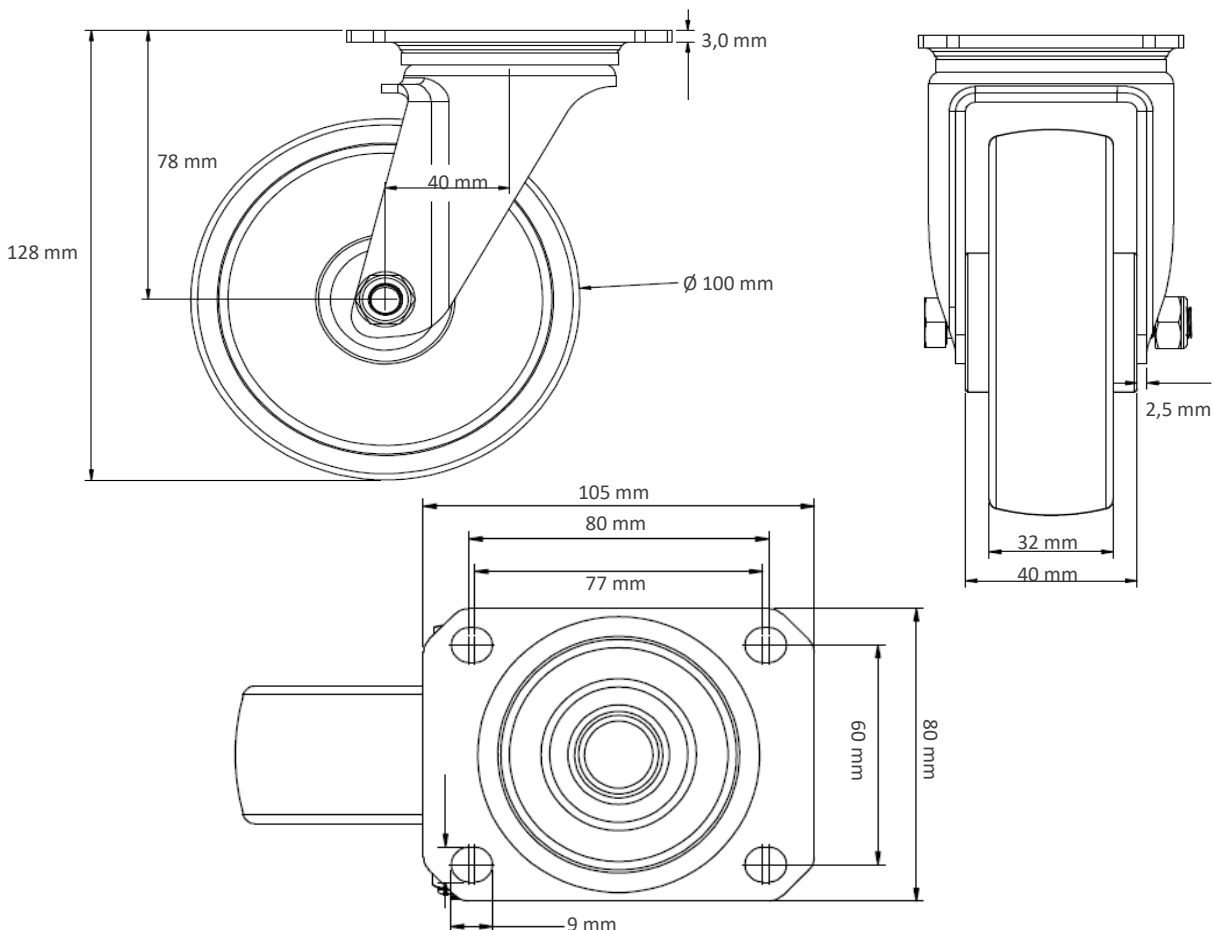

Deviation possible! All information is subject to change.