

Product Sheet



Item No. S P P 5 8 W C 160 P 4 R 2 R 0 N

housing / data

housing type	swivel castor
series	CASCOO Premium
fixing type	fixing plate
hole dimensions / hub width	105 x 80 mm / 60 mm
thickness of fixing / fork	3.50 mm / 3.00 mm
surface treatment	galvanized blue zinc



wheel / data

diameter	160 mm
wheel center	Polypropylene black
wheel tread	solid rubber grey
bearing	roller bearing
threadguard	no separate threadguard
hub width	59 mm
axle diameter	M 12
temperature range	-20°C - +60°C
dyn. load capacity	135 kg
test norm	DIN EN 12532

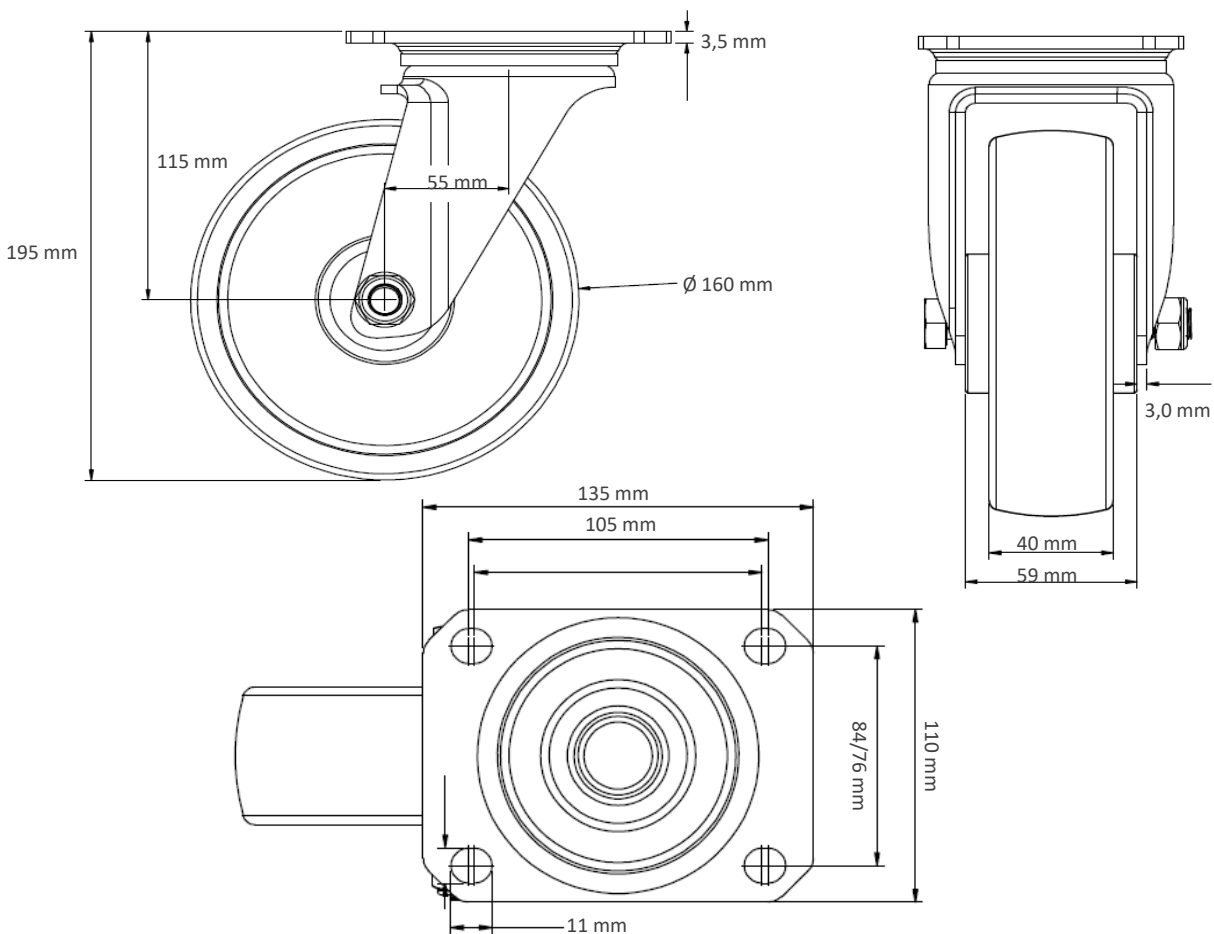
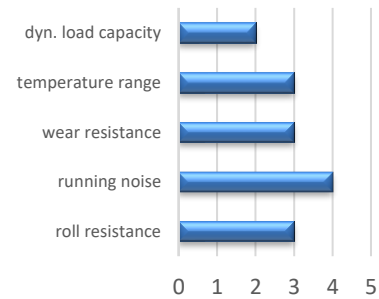

Deviation possible! All information is subject to change.