

Product Sheet



Item No. S P P 5 8 W C 200 P 2 G 2 B 3 2

housing / data

housing type	swivel castor
series	CASCOO Premium
fixing type	fixing plate
hole dimensions / hub width	105 x 80 mm / 60 mm
thickness of fixing / fork	3.50 mm / 3.00 mm
surface treatment	galvanized blue zinc



wheel / data

diameter	200 mm
wheel center	Polypropylene grey
wheel tread	thermopl. rubber 65° Shore A grey
bearing	single ball bearing
threadguard	small plastic threadguard
hub width	59 mm
axle diameter	M 12
temperature range	-20°C - +60°C
dyn. load capacity	250 kg
test norm	DIN: EN 12532

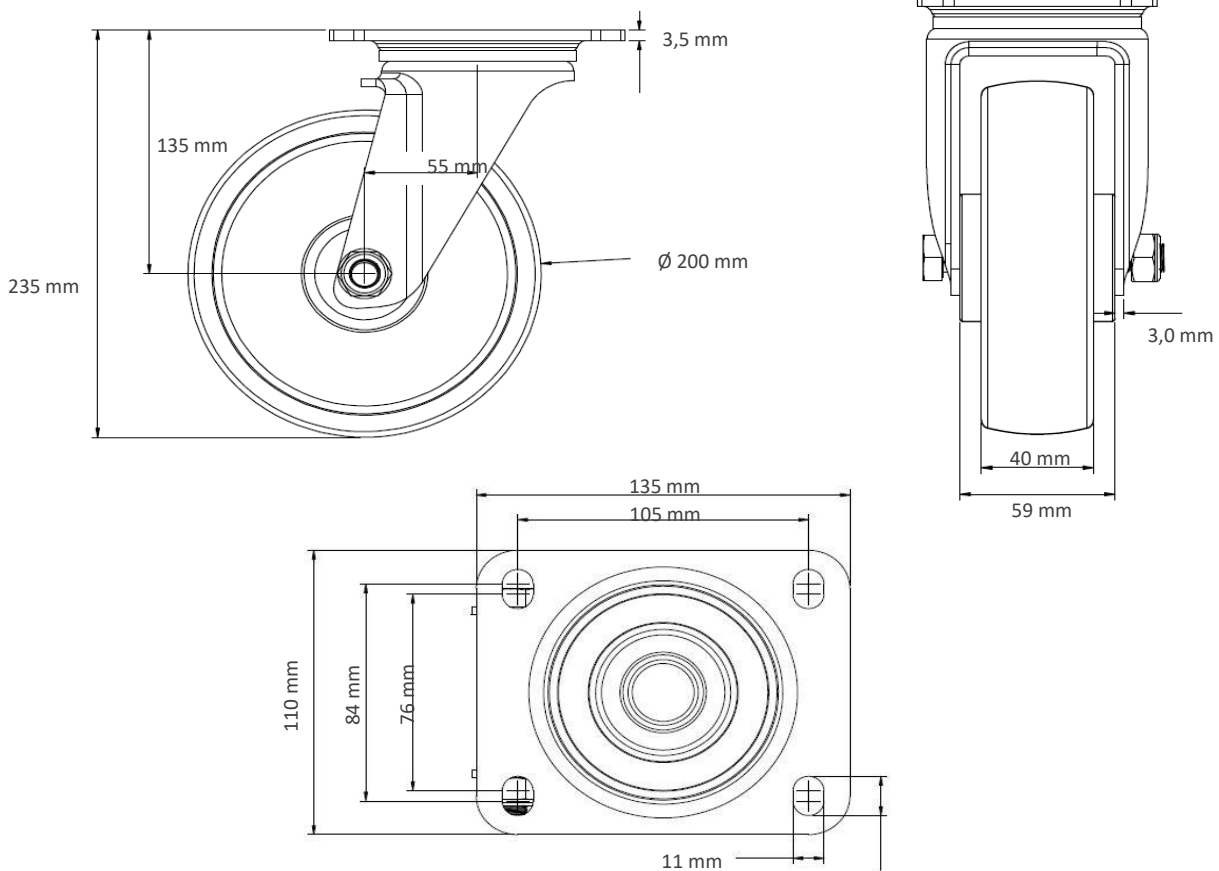
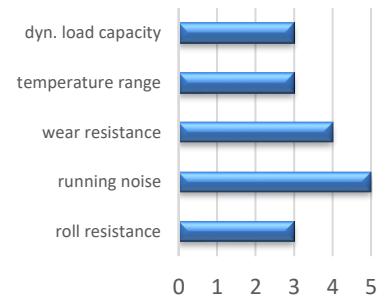

Deviation possible! All information is subject to change.