

Product Sheet



Item No. T H P 5 E W C 200 B A U 5 D 0 N

housing / data

housing type	swivel castor with total brake
series	heavy duty
fixing type	fixing plate
hole dimensions / hub width	105 x 80 mm / 60 mm
thickness of fixing / fork	5.00 mm / 4.00 mm
surface treatment	galvanized blue zinc



wheel / data

diameter	200 mm
wheel center	Aluminium (Heavy Duty)
wheel tread	Polyurethane brown
bearing	double ball bearing
threadguard	no separate threadguard
hub width	60 mm
axle diameter	M 12
temperature range	-20°C - +60°C
dyn. load capacity	700 kg
test norm	DIN: EN 12533

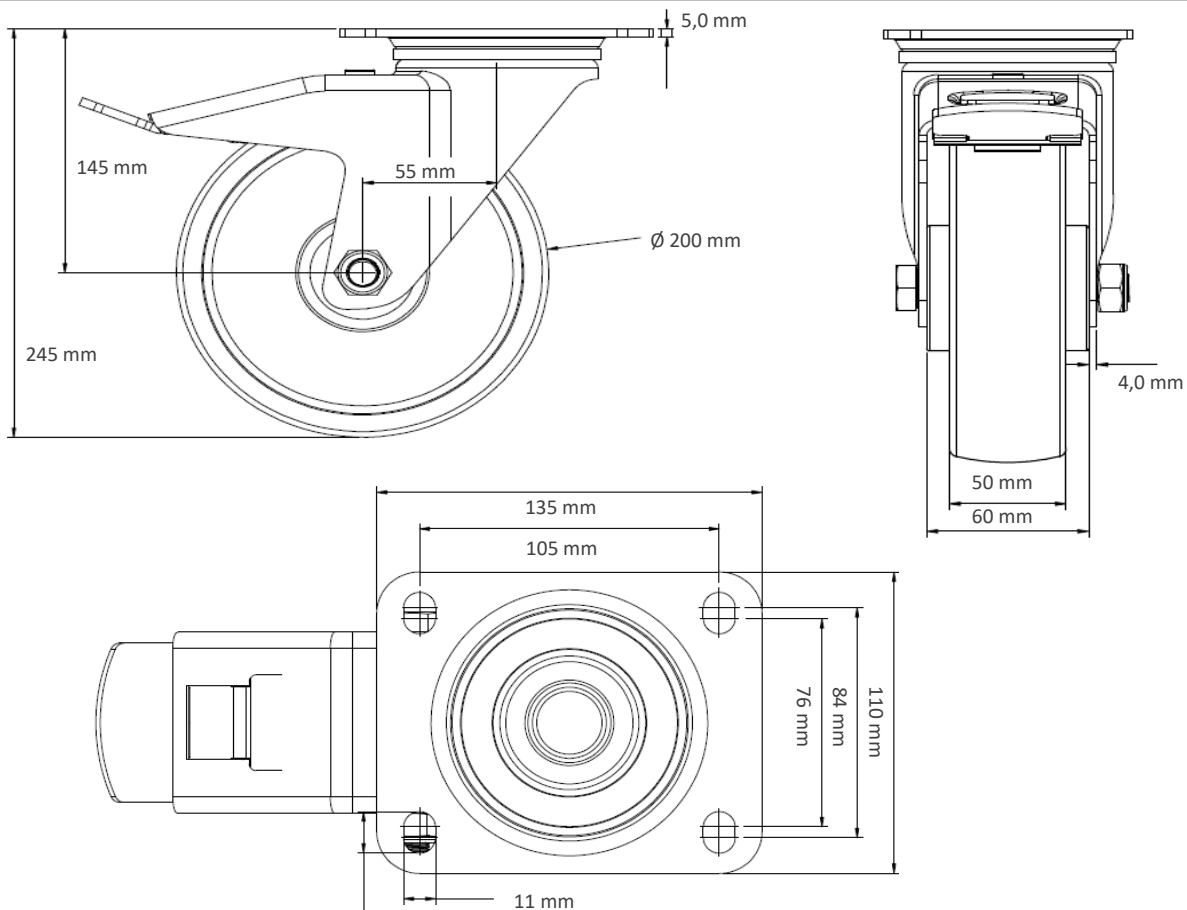
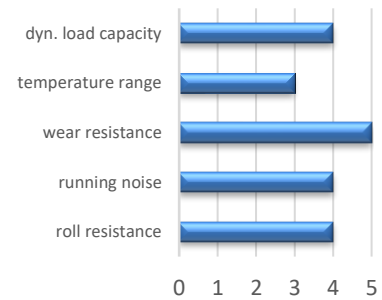

Deviation possible! All information is subject to change.