

Product Sheet



Item No. T H P 5 K W C 200 Z 0 Z 0 D 0 N

housing / data

housing type	swivel castor with total brake
series	heavy duty
fixing type	fixing plate
hole dimensions / hub width	105 x 80 mm / 60 mm
thickness of fixing / fork	6.00 mm / 5.00 mm
surface treatment	galvanized blue zinc



wheel / data

diameter	200 mm
wheel center	Polyamide (Heavy Duty) white
wheel tread	Polyamide (Heavy Duty) white
bearing	double ball bearing
threadguard	no separate threadguard
hub width	60 mm
axle diameter	M 12
temperature range	-40°C - +80°C
dyn. load capacity	1000 kg
test norm	DIN EN 12532

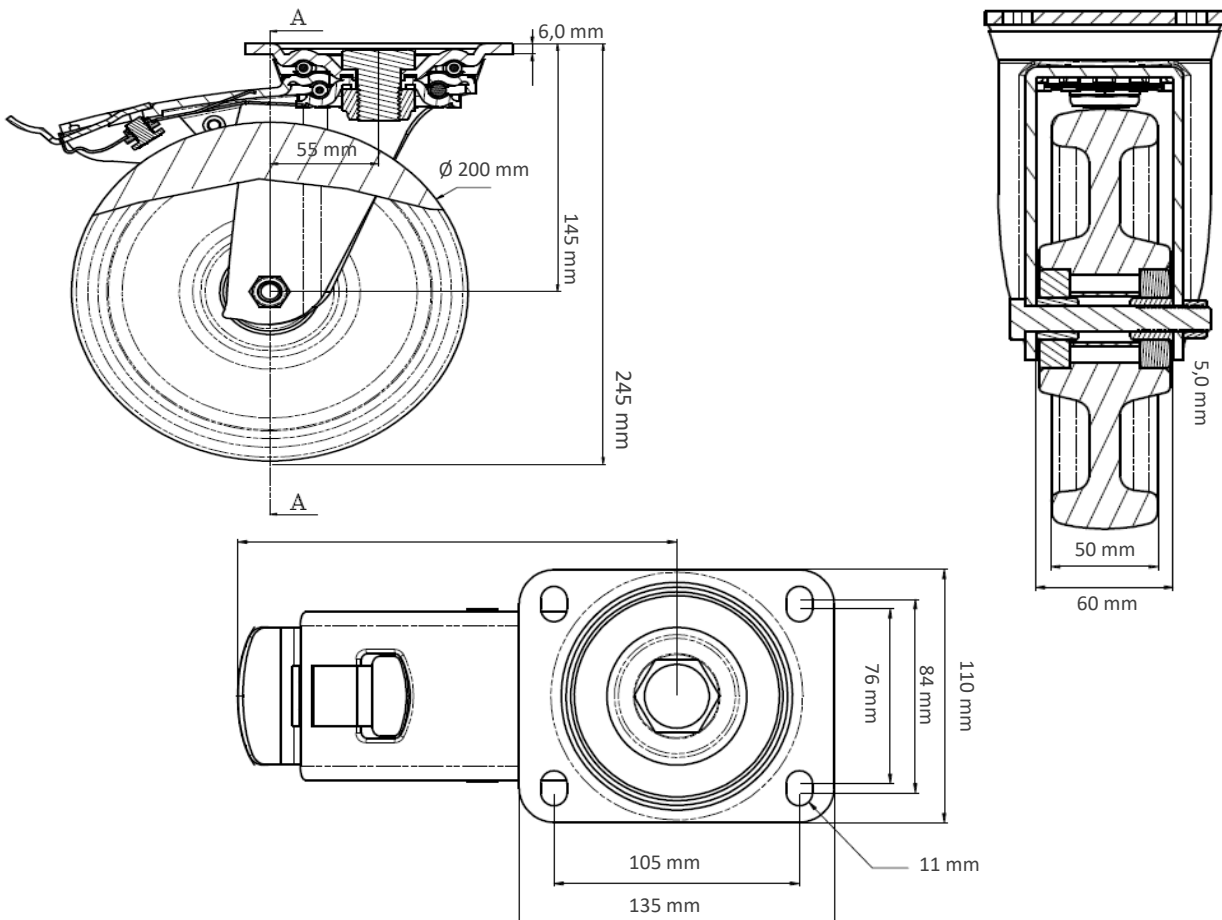
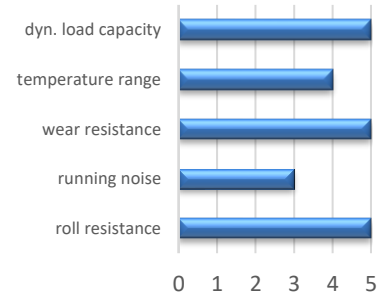

Deviation possible! All information is subject to change.