

Product Sheet



Item No. T P P 5 8 W C 200 P 0 P 0 R 1 W

housing / data

housing type	swivel castor with total brake
series	CASCOO Premium
fixing type	fixing plate
hole dimensions / hub width	105 x 80 mm / 60 mm
thickness of fixing / fork	3.50 mm / 3.00 mm
surface treatment	galvanized blue zinc



wheel / data

diameter	200 mm
wheel center	Polypropylene white
wheel tread	Polypropylene white
bearing	roller bearing
threadguard	small metal threadguard
hub width	59 mm
axle diameter	M 12
temperature range	-20°C - +60°C
dyn. load capacity	250 kg
test norm	DIN: EN 12532

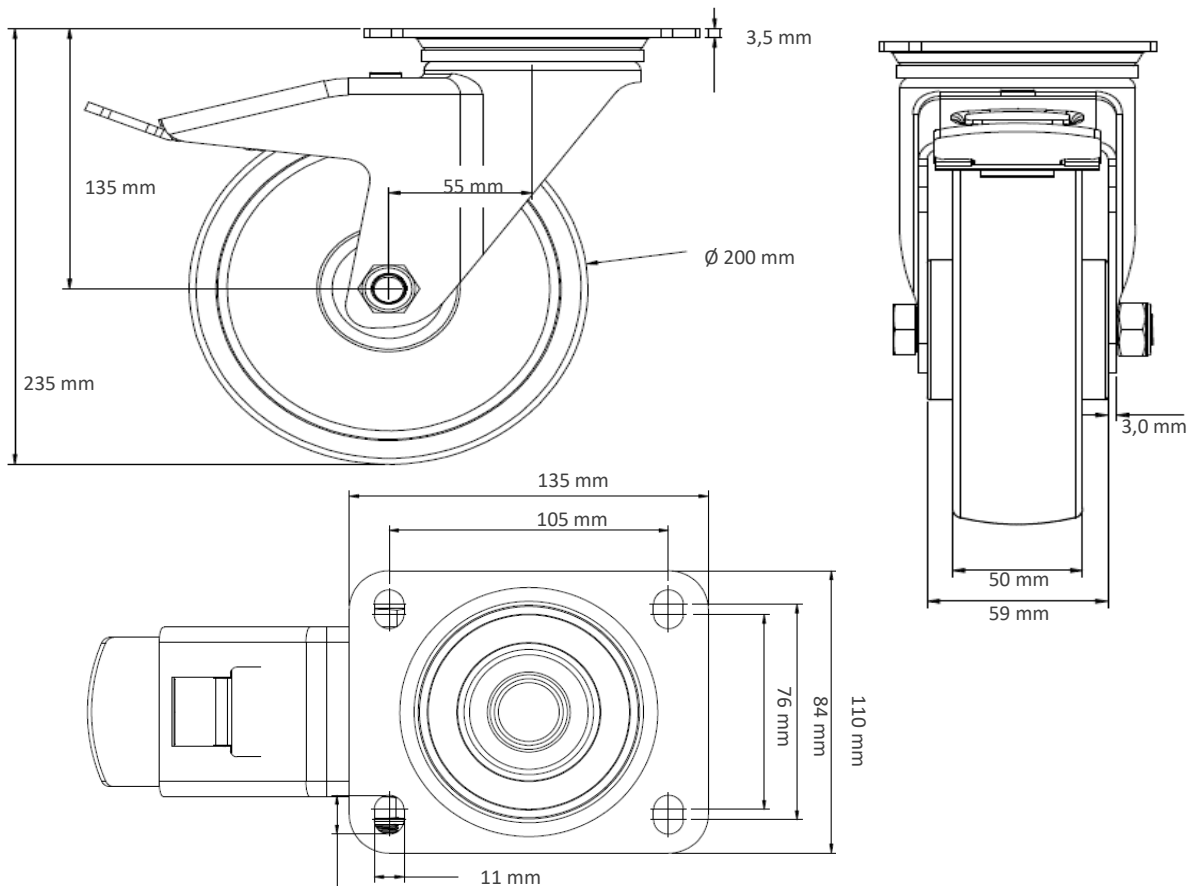
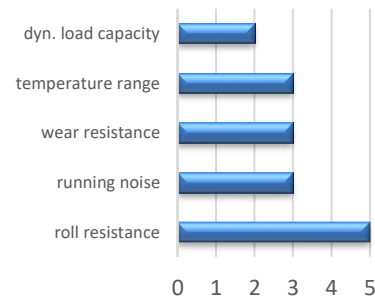

Deviation possible! All information is subject to change.